

IGBT MODULE (S-Series)

■ Features

- NPT-Technology
- Square SC SOA at $10 \times I_C$
- High Short Circuit Withstand-Capability
- Small Temperature Dependence of the Turn-Off Switching Loss
- Low Losses And Soft Switching

■ Applications

- High Power Switching
- A.C. Motor Controls
- D.C. Motor Controls
- Uninterruptible Power Supply

■ Outline Drawing

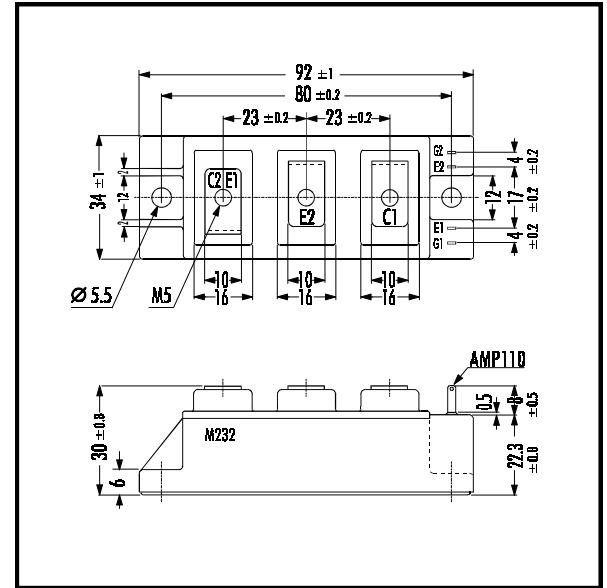

■ Maximum Ratings and Characteristics

• Absolute Maximum Ratings ($T_c=25^\circ\text{C}$)

Items	Symbols	Ratings	Units	
Collector-Emitter Voltage	V_{CES}	1200	V	
Gate -Emitter Voltage	V_{GES}	± 20		
Collector Current	Continuous	I_C	100 / 75	
	1ms	$I_C \text{ PULSE}$	200 / 150	
	Continuous	$-I_C$	75	
	1ms	$-I_C \text{ PULSE}$	150	
Max. Power Dissipation	P_C	600	W	
Operating Temperature	T_j	+150	$^\circ\text{C}$	
Storage Temperature	T_{stg}	-40 ~ +125		
Isolation Voltage *1	A.C. 1min.	V_{is}	2500	V
Screw Torque	Mounting *2	3.5	Nm	
	Terminals *2	3.5		

Note: 1*: All Terminals should be connected together when isolation test will be done.
2*: Recommendable Value, 2.5 - 3.5 Nm (M5)

■ Equivalent Circuit

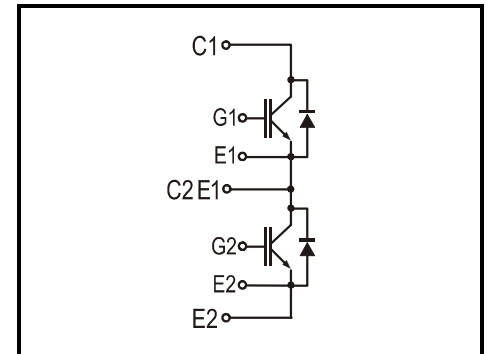

• Electrical Characteristics (at $T_j=25^\circ\text{C}$)

Items	Symbols	Test Conditions	Min.	Typ.	Max.	Units
Zero Gate Voltage Collector Current	I_{CES}	$V_{GE}=0V$ $V_{CE}=1200V$			1.0	mA
Gate-Emitter Leakage Current	I_{GES}	$V_{CE}=0V$ $V_{GE}=\pm 20V$			200	nA
Gate-Emitter Threshold Voltage	$V_{GE(th)}$	$V_{GE}=20V$ $I_C=75mA$	5.5	7.2	8.5	V
Collector-Emitter Saturation Voltage	$V_{CE(sat)}$	$V_{GE}=15V$ $I_C=75A$		2.3	2.6	
Input Capacitance	C_{ies}	$V_{GE}=0V$		9'000		pF
Output Capacitance	C_{oes}	$V_{CE}=10V$		1'875		
Reverse Transfer Capacitance	C_{res}	$f=1MHz$		1'650		
Turn-on Time	t_{ON}	$V_{CC}=600V$		0.35	1.2	μs
	$t_{r,x}$	$I_C=75A$		0.25	0.6	
	$t_{r,i}$	$V_{GE}=\pm 15V$		0.10		
Turn-off Time	t_{OFF}	$R_G=16\Omega$		0.45	1.0	μs
	t_f	Inductive Load		0.08	0.3	
Diode Forward On-Voltage	V_F	$I_F=75A$; $V_{GE}=0V$	$T_j=25^\circ\text{C}$	2.3	3.0	V
Reverse Recovery Time	t_{rr}	$I_F=75A$	$T_j=125^\circ\text{C}$	2.0		

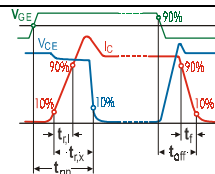

• Thermal Characteristics

Items	Symbols	Test Conditions	Min.	Typ.	Max.	Units
Thermal Resistance	$R_{th(j-c)}$	IGBT			0.21	$^\circ\text{C/W}$
	$R_{th(j-e)}$	Diode			0.47	
	$R_{th(c-f)}$	With Thermal Compound		0.05		

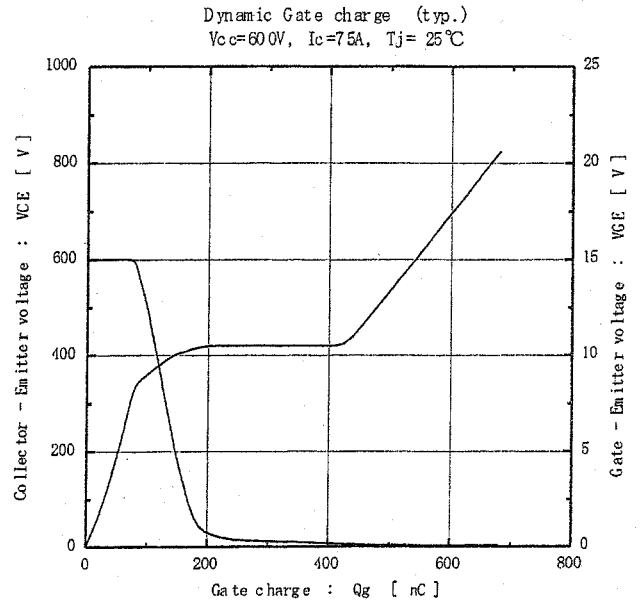
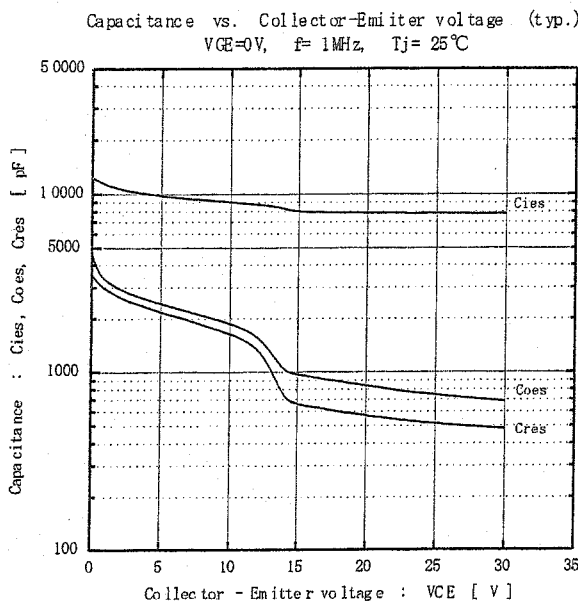
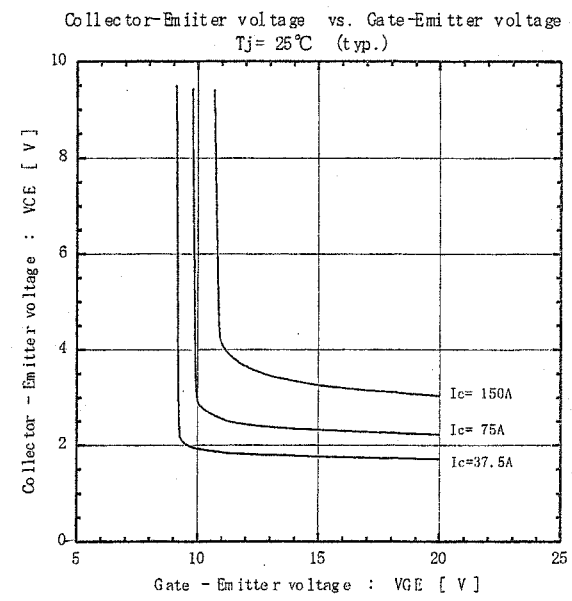
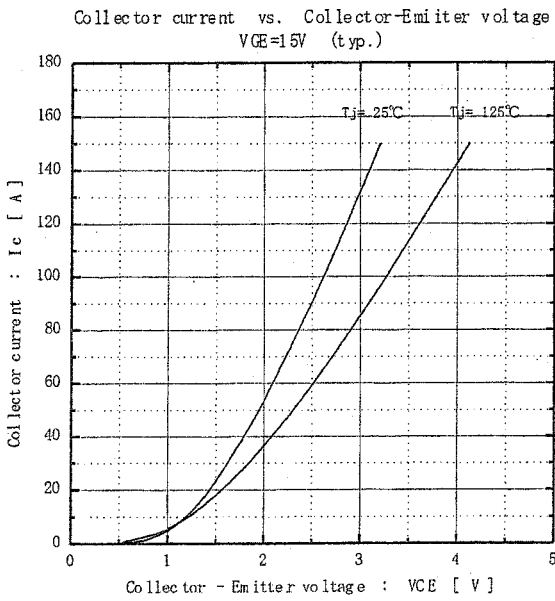
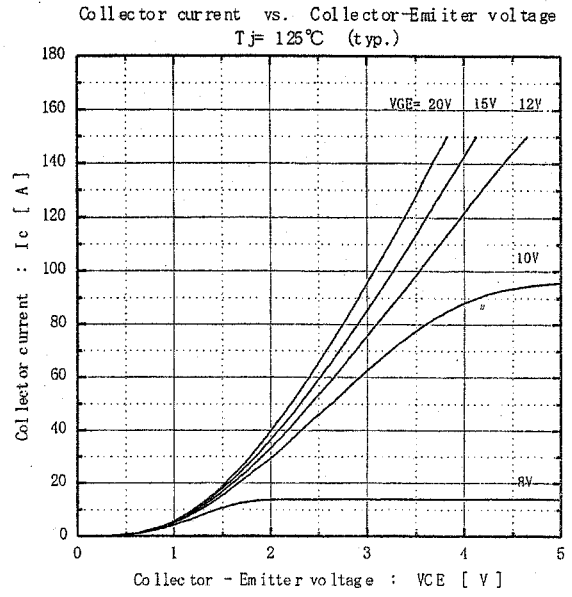
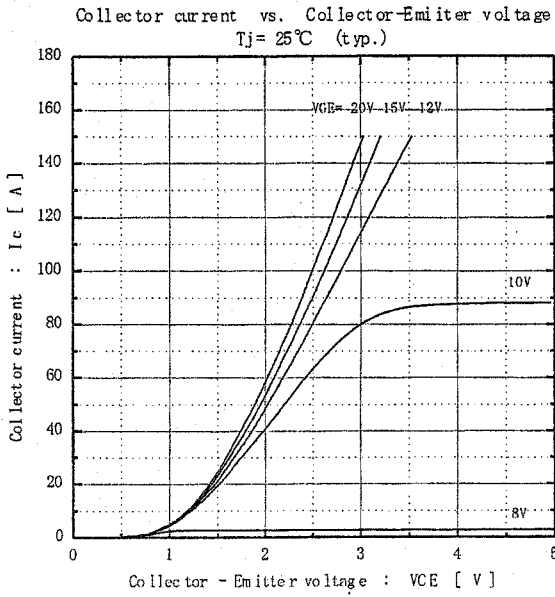

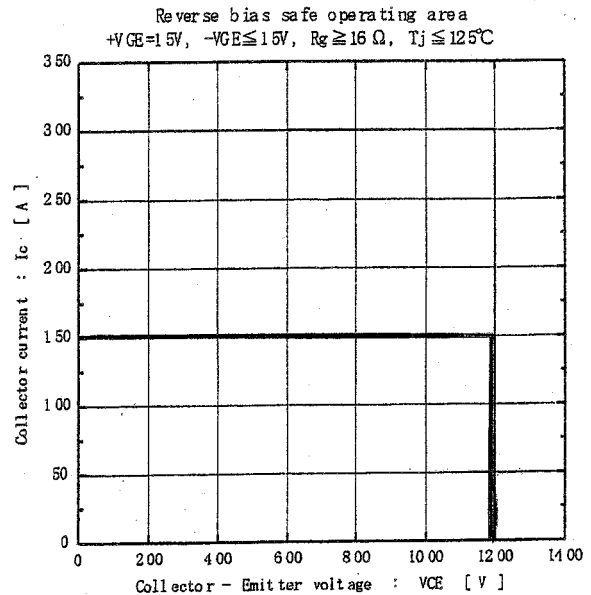
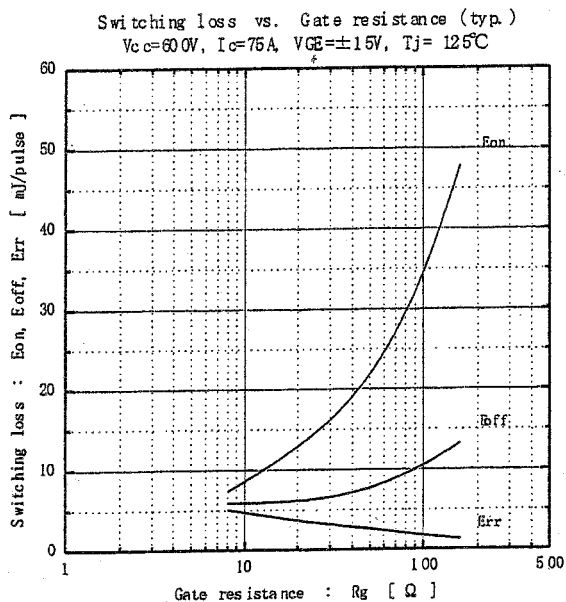
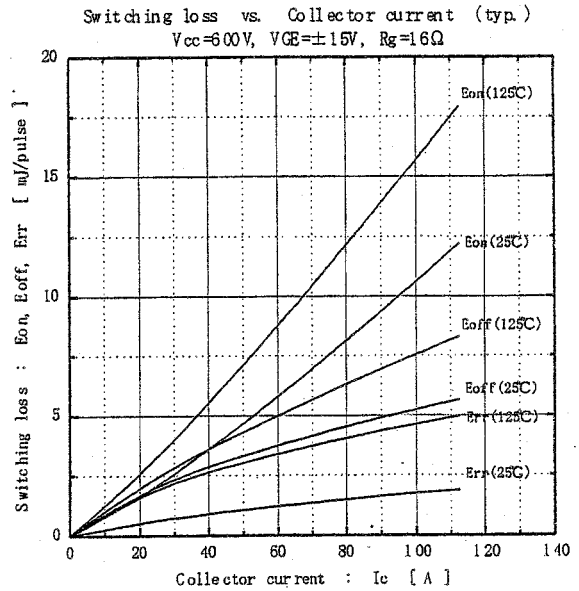
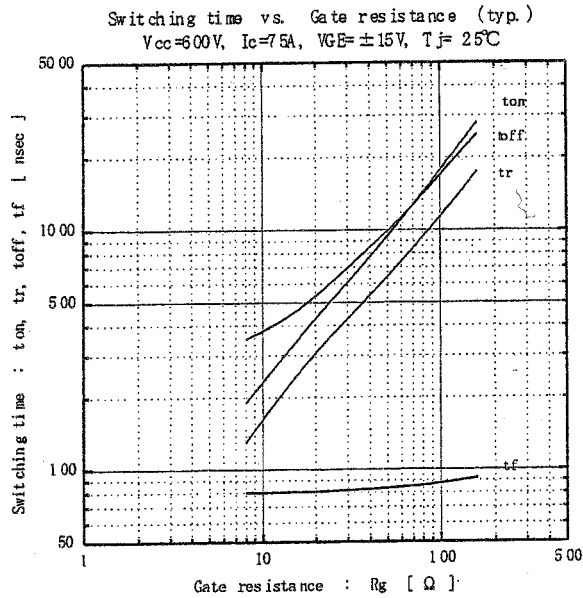
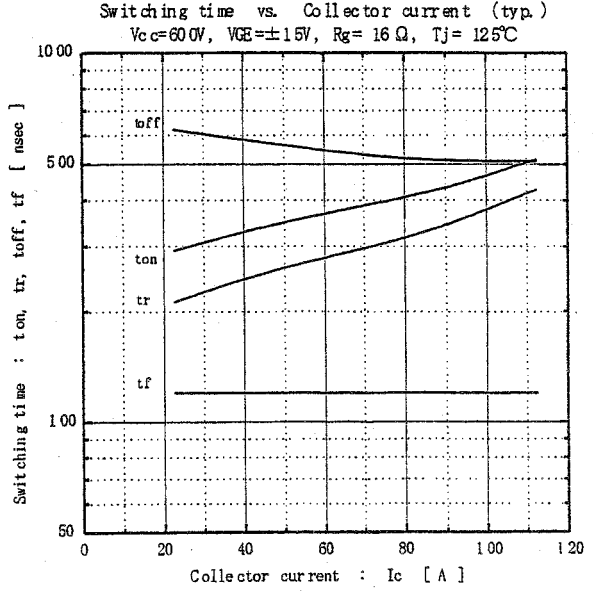
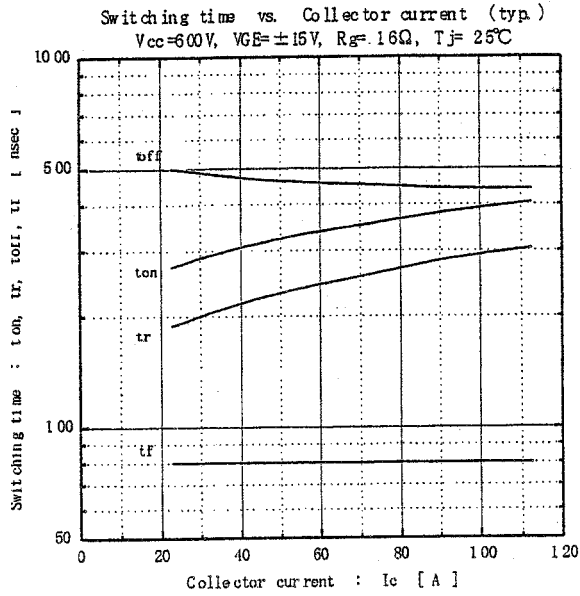

Forward current vs. Forward on voltage (typ.)

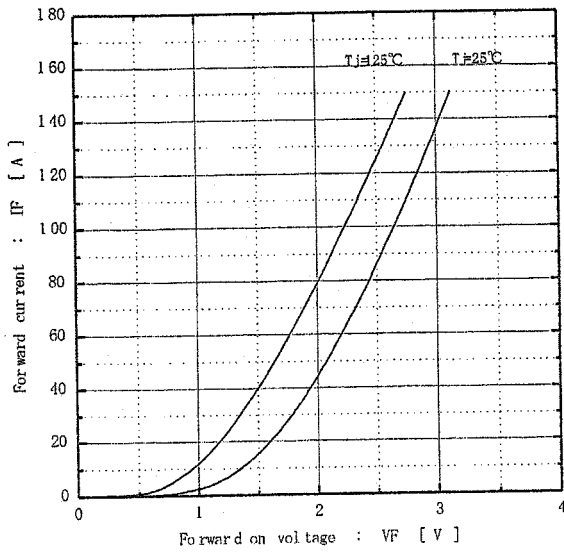

Reverse recovery characteristics (typ.)
Vcc=600V, VGE=±15V, Rg=16Ω

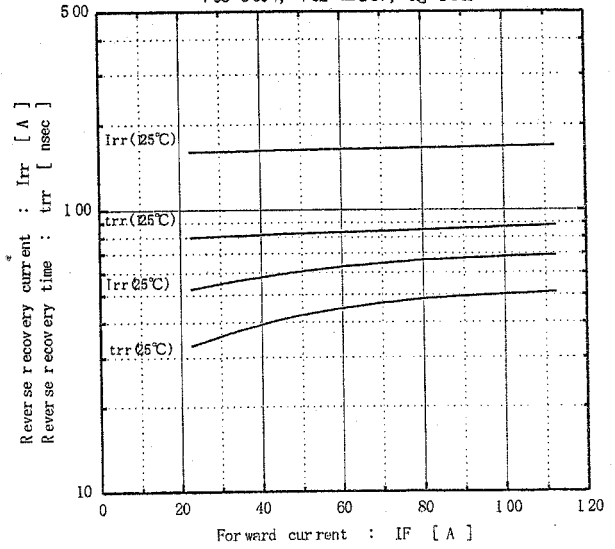

Transient thermal resistance

