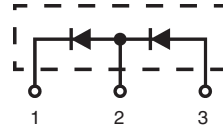
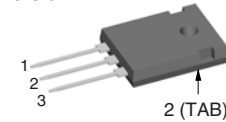
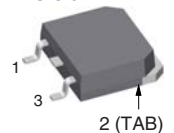
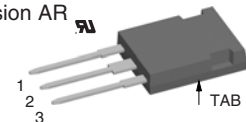

Phase-leg Rectifier Diode

$V_{RRM} = 1200/1600 \text{ V}$
 $I_{F(RMS)} = 2 \times 43 \text{ A}$
 $I_{F(AV)M} = 2 \times 28 \text{ A}$

V_{RSM} V	V_{RRM} V	TO-247 AD Type	TO-268 AA	ISOPLUS247™
1300	1200	DSP 25-12A	DSP 25-12AT	
1700	1600	DSP 25-16A	DSP 25-16AT	DSP 25-16AR

TO-247 AD
Version A

TO-268 AA
Version AT

ISOPLUS 247™
Version AR

1 = Cathode, 2 = Anode/Cathode, 3 = Anode

Symbol	Conditions	Maximum Ratings
$I_{F(RMS)}$	$T_{VJ} = T_{VJM}$	43 A
$I_{F(AV)M}$	$T_{case} = 100^{\circ}\text{C}; 180^{\circ}$ sine	28 A
I_{FSM}	$T_{VJ} = 45^{\circ}\text{C}; t = 10 \text{ ms}$ (50 Hz), sine	300 A
	$t = 8.3 \text{ ms}$ (60 Hz), sine	330 A
	$T_{VJ} = 150^{\circ}\text{C}; t = 10 \text{ ms}$ (50 Hz), sine	270 A
	$t = 8.3 \text{ ms}$ (60 Hz), sine	300 A
I^2t	$T_{VJ} = 45^{\circ}\text{C}$ $t = 10 \text{ ms}$ (50 Hz), sine	450 A ² s
	$t = 8.3 \text{ ms}$ (60 Hz), sine	450 A ² s
	$T_{VJ} = 150^{\circ}\text{C}; t = 10 \text{ ms}$ (50 Hz), sine	340 A ² s
	$t = 8.3 \text{ ms}$ (60 Hz), sine	325 A ² s
T_{VJ}		-40...+180 °C
T_{VJM}		180 °C
T_{stg}		-40...+150 °C
M_d^*	mounting torque M3 0.8...1.2	Nm
F_C	mounting force with clip	20...120 N
V_{ISOL}^{**}	50/60 Hz, RMS, $t = 1$ minute, leads-to-tab	2500 V~
Weight	TO-268 / TO-247 4 / 6	g

* Verson A only; ** Version AR only

Features

- International standard packages JEDEC TO-247 AD and TO-268 AA surface mountable
- For single and three phase bridge configuration
- Planar passivated chips
- Epoxy meets UL 94V-0 flammability classification
- Version AR isolated and UL registered E153432

Symbol	Conditions	Characteristic Values
I_R	$T_{VJ} = 150^{\circ}\text{C}$ $V_R = V_{RRM}$	$\leq 2 \text{ mA}$
V_F	$I_F = 55 \text{ A}; T_{VJ} = 25^{\circ}\text{C}$	$\leq 1.6 \text{ V}$
V_{T0}	For power-loss calculations only	0.8 V
r_T	$T_{VJ} = T_{VJM}$	15 mΩ
R_{thJC}	DC current	1.5 K/W
R_{thCH}	DC current (with heatsink compound)	0.4 K/W
a	Maximum allowable acceleration	100 m/s ²

Data according to IEC 60747 and refer to a single diode

TO-247 AD

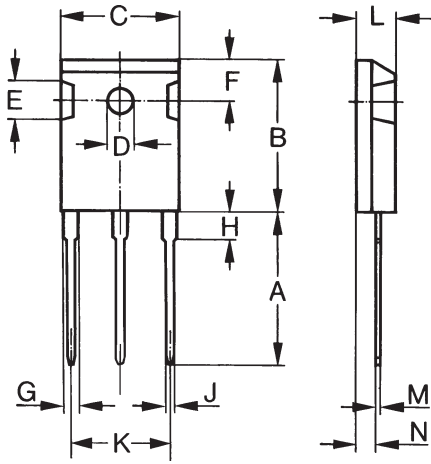

Dim.	Millimeter		Inches	
	Min.	Max.	Min.	Max.
A	19.81	20.32	0.780	0.800
B	20.80	21.46	0.819	0.845
C	15.75	16.26	0.610	0.640
D	3.55	3.65	0.140	0.144
E	4.32	5.49	0.170	0.216
F	5.4	6.2	0.212	0.244
G	1.65	2.13	0.065	0.084
H	-	4.5	-	0.177
J	1.0	1.4	0.040	0.055
K	10.8	11.0	0.426	0.433
L	4.7	5.3	0.185	0.209
M	0.4	0.8	0.016	0.031
N	1.5	2.49	0.087	0.102

ISOPLUS247™

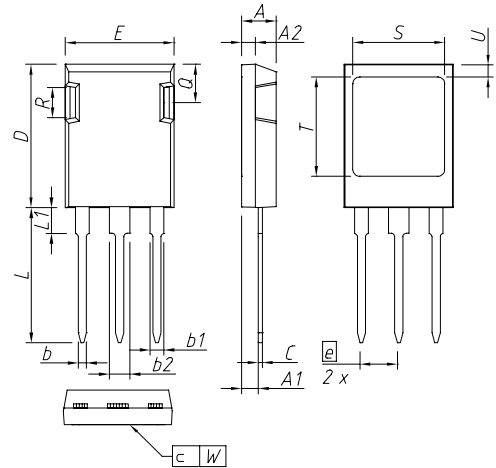

DIM.	MILLIMETER		INCHES	
	MIN	MAX	MIN	MAX
A	4,83	5,21	0,190	0,205
A1	2,29	2,54	0,090	0,100
A2	1,91	2,16	0,075	0,085
b	1,14	1,40	0,045	0,055
b1	1,91	2,15	0,075	0,085
b2	2,92	3,20	0,115	0,126
C	0,61	0,83	0,024	0,033
D	20,80	21,34	0,819	0,840
E	15,75	16,13	0,620	0,635
e	5,45 BSC		0,215 BSC	
L	19,81	20,60	0,780	0,811
L1	3,81	4,38	0,150	0,172
Q	5,59	6,20	0,220	0,244
R	4,32	4,85	0,170	0,191
S	13,21	13,72	0,520	0,540
T	15,75	16,26	0,620	0,640
U	1,65	2,03	0,065	0,080
W	-	0,10	-	0,004

The convex bow of substrate is typ. < 0.04 mm over plastic surface level of device bottom side
 This drawing will meet all dimensions requirement of JEDEC outline TO-247 AD except screw hole and except Lmax.

TO-268 AA

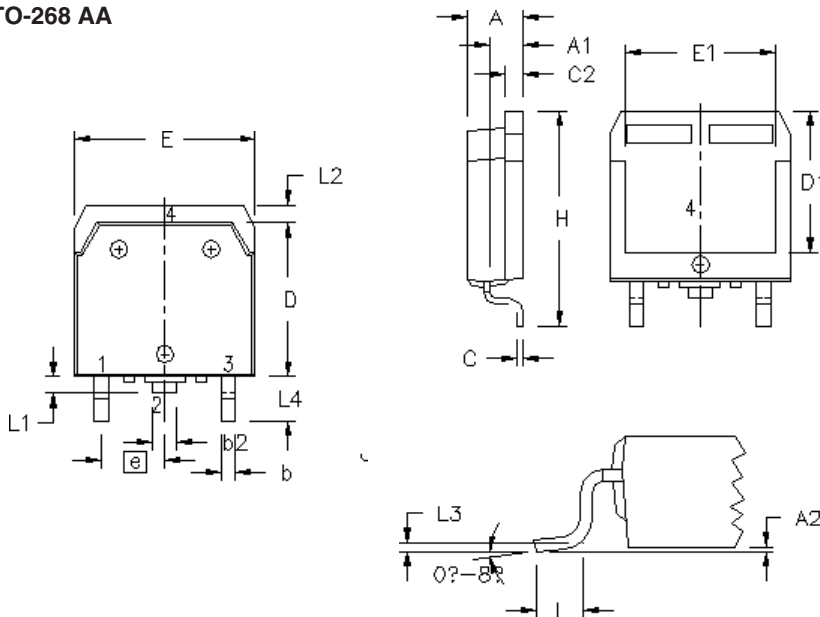

Dim.	Millimeter		Inches	
	Min.	Max.	Min.	Max.
A	4.9	5.1	.193	.201
A ₁	2.7	2.9	.106	.114
A ₂	.02	.25	.001	.010
b	1.15	1.45	.045	.057
b ₂	1.9	2.1	.75	.83
C	.4	.65	.016	.026
D	13.80	14.00	.543	.551
E	15.85	16.05	.624	.632
E ₁	13.3	13.6	.524	.535
e	5.45 BSC		.215 BSC	
H	18.70	19.10	.736	.752
L	2.40	2.70	.094	.106
L ₁	1.20	1.40	.047	.055
L ₂	1.00	1.15	.039	.045
L ₃	0.25 BSC		.010 BSC	
L ₄	3.80	4.10	.150	.161

IXYS reserves the right to change limits, test conditions and dimensions

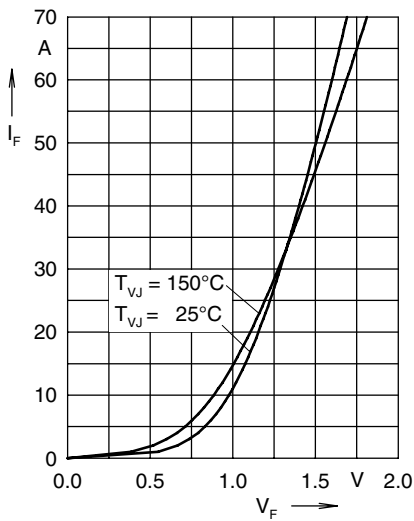

Fig. 1 Forward current versus voltage drop per diode

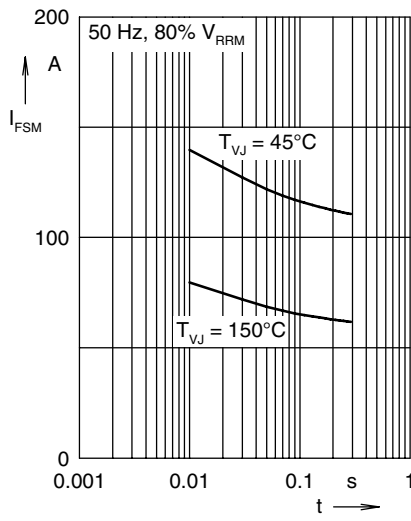

Fig. 2 Surge overload current

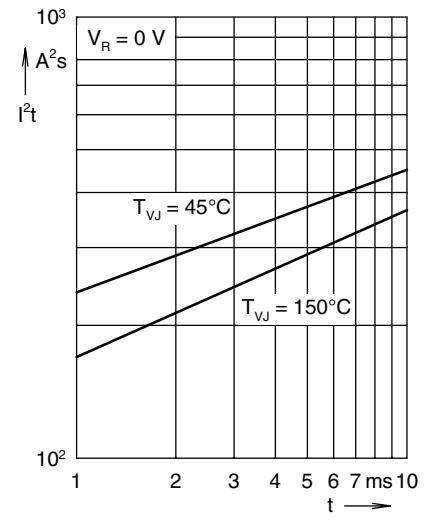

Fig. 3 I^2t versus time per diode

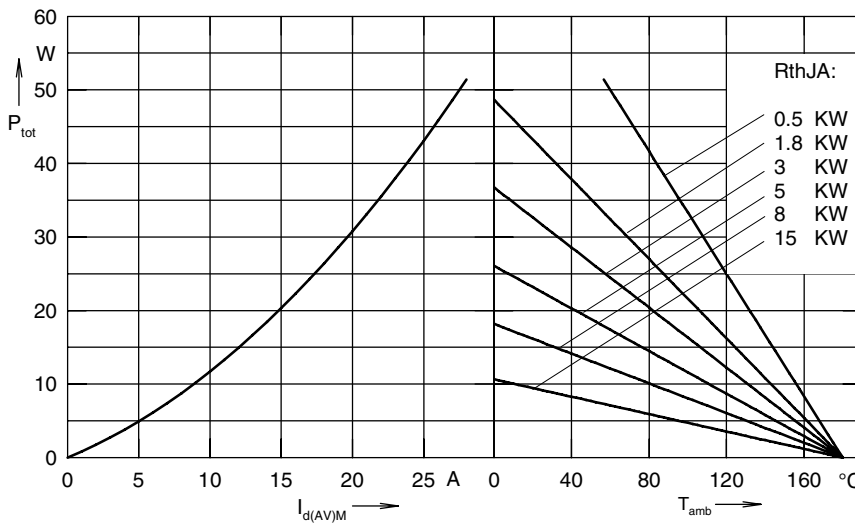

Fig. 4 Power dissipation versus direct output current and ambient temperature, sine 180°

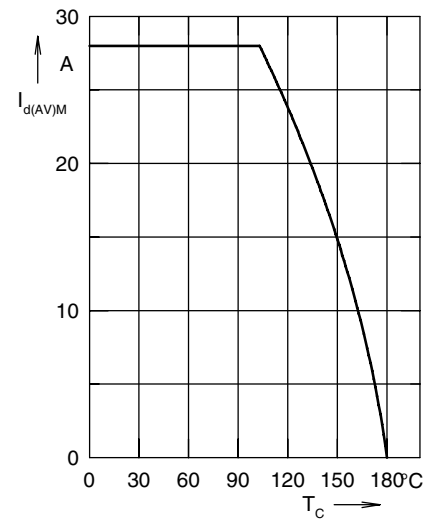

Fig. 5 Max. forward current versus case temperature

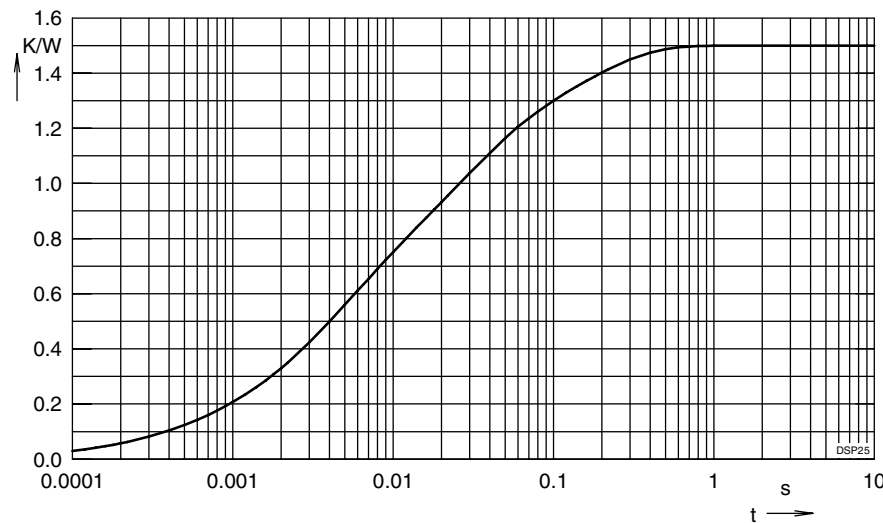

Fig. 6 Transient thermal impedance junction to case

Constants for Z_{thjC} calculation:

i	R_{thi} (K/W)	t_i (s)
1	0.06075	0.0004
2	0.183	0.00256
3	0.3405	0.0045
4	0.543	0.0242
5	0.3728	0.15