

Phase Control Thyristor Types N0491WC020 to N0491WC080

Absolute Maximum Ratings

| | VOLTAGE RATINGS | MAXIMUM LIMITS | UNITS |
|-----------|---|----------------|-------|
| V_{DRM} | Repetitive peak off-state voltage, (note 1) | 200-800 | V |
| V_{DSM} | Non-repetitive peak off-state voltage, (note 1) | 200-800 | V |
| V_{RRM} | Repetitive peak reverse voltage, (note 1) | 200-800 | V |
| V_{RSM} | Non-repetitive peak reverse voltage, (note 1) | 300-900 | V |

| | OTHER RATINGS | MAXIMUM LIMITS | UNITS |
|---------------|--|------------------|-------------|
| $I_{T(AV)}$ | Mean on-state current. $T_{sink}=55^{\circ}C$, (note 2) | 491 | A |
| $I_{T(AV)}$ | Mean on-state current. $T_{sink}=85^{\circ}C$, (note 2) | 328 | A |
| $I_{T(AV)}$ | Mean on-state current. $T_{sink}=85^{\circ}C$, (note 3) | 176 | A |
| $I_{T(RMS)}$ | Nominal RMS on-state current. $T_{sink}=25^{\circ}C$, (note 2) | 984 | A |
| $I_{T(d.c.)}$ | D.C. on-state current. $T_{sink}=25^{\circ}C$, (note 4) | 817 | A |
| I_{TSM} | Peak non-repetitive surge $t_p=10ms$, $V_{rm}=0.6V_{RRM}$, (note 5) | 6000 | A |
| I_{TSM2} | Peak non-repetitive surge $t_p=10ms$, $V_{rm}\leq 10V$, (note 5) | 6600 | A |
| I^2t | I^2t capacity for fusing $t_p=10ms$, $V_{rm}=0.6V_{RRM}$, (note 5) | 180×10^3 | A^2s |
| I^2t | I^2t capacity for fusing $t_p=10ms$, $V_{rm}\leq 10V$, (note 5) | 218×10^3 | A^2s |
| di_T/dt | Maximum rate of rise of on-state current (repetitive), (Note 6) | 500 | $A/\mu s$ |
| di_T/dt | Maximum rate of rise of on-state current (non-repetitive), (Note 6) | 1000 | $A/\mu s$ |
| V_{RGM} | Peak reverse gate voltage | 5 | V |
| $P_{G(AV)}$ | Mean forward gate power | 2 | W |
| P_{GM} | Peak forward gate power | 30 | W |
| V_{GD} | Non-trigger gate voltage, (Note 7) | 0.25 | V |
| T_{HS} | Operating temperature range | -40 to +125 | $^{\circ}C$ |
| T_{stg} | Storage temperature range | -40 to +150 | $^{\circ}C$ |

Notes: -

- 1) De-rating factor of 0.13% per $^{\circ}C$ is applicable for T_j below $25^{\circ}C$.
- 2) Double side cooled, single phase; 50Hz, 180° half-sinewave.
- 3) Single side cooled, single phase; 50Hz, 180° half-sinewave.
- 4) Double side cooled.
- 5) Half-sinewave, $125^{\circ}C$ T_j initial.
- 6) $V_D=67\% V_{DRM}$, $I_{TM}=2000A$, $I_{FG}=2A$, $t_r\leq 0.5\mu s$, $T_{case}=125^{\circ}C$.
- 7) Rated V_{DRM} .

Characteristics

| | PARAMETER | MIN. | TYP. | MAX. | TEST CONDITIONS (Note 1) | UNITS |
|----------------|--|------|------|-------|--|------------|
| V_{TM} | Maximum peak on-state voltage | - | - | 1.26 | $I_{TM}=770A$ | V |
| V_0 | Threshold voltage | - | - | 0.85 | | V |
| r_s | Slope resistance | - | - | 0.535 | | m Ω |
| dv/dt | Critical rate of rise of off-state voltage | 200 | - | - | $V_D=80\% V_{DRM}$, linear ramp, Gate O/C | V/ μ s |
| I_{DRM} | Peak off-state current | - | - | 20 | Rated V_{DRM} | mA |
| I_{RRM} | Peak reverse current | - | - | 20 | Rated V_{RRM} | mA |
| V_{GT} | Gate trigger voltage | - | - | 3.0 | $T_j=25^\circ C$, $V_D=10V$, $I_T=2A$ | V |
| I_{GT} | Gate trigger current | - | - | 150 | | mA |
| I_H | Holding current | - | - | 600 | $T_j=25^\circ C$ | mA |
| t_{gd} | Gate controlled turn-on delay time | - | 0.5 | 1.0 | $V_D=67\%V_{DRM}$, $I_{TM}=500A$, $di/dt=10A/\mu s$, | μ s |
| t_{gt} | Turn-on time | - | 1.0 | 2.0 | $I_{FG}=2A$, $t_r=0.5\mu s$, $T_j=25^\circ C$ | |
| Q_{rr} | Recovered Charge | - | 250 | - | | μ C |
| Q_{ra} | Recovered Charge, 50% chord | - | 160 | 225 | | μ C |
| I_{rm} | Reverse recovery current | - | 65 | - | $I_{TM}=300A$, $t_p=500\mu s$, $di/dt=20A/\mu s$, $V_r=50V$ | A |
| t_{rr} | Reverse recovery time, 50% chord | - | 5.0 | - | | μ s |
| t_q | Turn-off time | - | 100 | 140 | $I_{TM}=300A$, $t_p=500\mu s$, $di/dt=20A/\mu s$, $V_r=50V$, $V_{dr}=80\%V_{DRM}$, $dV_{dr}/dt=20V/\mu s$ | μ s |
| | | - | 150 | 200 | $I_{TM}=300A$, $t_p=500\mu s$, $di/dt=20A/\mu s$, $V_r=50V$, $V_{dr}=80\%V_{DRM}$, $dV_{dr}/dt=200V/\mu s$ | |
| $R_{th(j-hs)}$ | Thermal resistance, junction to heatsink | - | - | 0.095 | Double side cooled | K/W |
| | | - | - | 0.210 | Single side cooled | K/W |
| F | Mounting force | 3.3 | - | 5.5 | | kN |
| W_t | Weight | - | 70 | - | | g |

Notes: -

1) Unless otherwise indicated $T_j=125^\circ C$.

Notes on Ratings and Characteristics**1.0 Voltage Grade Table**

| Voltage Grade | V_{DRM} V_{DSM} V_{RRM} V | V_{RSM} V | V_D V_R DC V |
|---------------|------------------------------------|----------------|---------------------|
| 02 | 200 | 300 | 140 |
| 03 | 300 | 400 | 210 |
| 04 | 400 | 500 | 260 |
| 06 | 600 | 700 | 420 |
| 08 | 800 | 900 | 560 |

2.0 Extension of Voltage Grades

This report is applicable to other and higher voltage grades when supply has been agreed by Sales/Production.

3.0 De-rating Factor

A blocking voltage de-rating factor of 0.13%/°C is applicable to this device for T_j below 25°C.

4.0 Repetitive dv/dt

Standard dv/dt is 1000V/μs.

5.0 Rate of rise of on-state current

The maximum un-primed rate of rise of on-state current must not exceed 1000A/μs at any time during turn-on on a non-repetitive basis. For repetitive performance, the on-state rate of rise of current must not exceed 500A/μs at any time during turn-on. Note that these values of rate of rise of current apply to the total device current including that from any local snubber network.

6.0 Gate Drive

The recommended pulse gate drive is 30V, 30Ω with a short-circuit current rise time of not more than 0.5μs. This gate drive must be applied when using the full di/dt capability of the device.

The pulse duration may need to be configured according to the application but should be no shorter than 20μs, otherwise an increase in pulse current may be needed to supply the necessary charge to trigger.

7.0 Computer Modelling Parameters**7.1 Device Dissipation Calculations**

$$I_{AV} = \frac{-V_0 + \sqrt{V_0^2 + 4 \cdot ff^2 \cdot r_s \cdot W_{AV}}}{2 \cdot ff^2 \cdot r_s} \quad \text{and:} \quad W_{AV} = \frac{\Delta T}{R_{th}}$$

$$\Delta T = T_{j\max} - T_{Hs}$$

Where $V_0=0.85V$, $r_s=0.535m\Omega$,

R_{th} = Supplementary thermal impedance, see table below.

ff = Form factor, see table below.

| Supplementary Thermal Impedance | | | | | | | |
|---------------------------------|---------|---------|---------|---------|---------|---------|-------|
| Conduction Angle | 30° | 60° | 90° | 120° | 180° | 270° | d.c. |
| Square wave Double Side Cooled | 0.1125 | 0.1089 | 0.106 | 0.10359 | 0.10003 | 0.09634 | 0.095 |
| Square wave Single Side Cooled | 0.2277 | 0.2231 | 0.2198 | 0.2175 | 0.2142 | 0.2109 | 0.21 |
| Sine wave Double Side Cooled | 0.10937 | 0.10497 | 0.10232 | 0.10021 | 0.09531 | | |
| Sine wave Single Side Cooled | 0.2232 | 0.2182 | 0.2156 | 0.2137 | 0.2095 | | |

| Form Factors | | | | | | | |
|------------------|------|------|------|------|------|------|------|
| Conduction Angle | 30° | 60° | 90° | 120° | 180° | 270° | d.c. |
| Square wave | 3.46 | 2.45 | 2 | 1.73 | 1.41 | 1.15 | 1 |
| Sine wave | 3.98 | 2.78 | 2.22 | 1.88 | 1.57 | | |

7.2 Calculating V_T using ABCD Coefficients

The on-state characteristic I_T vs. V_T , on page 5 is represented in two ways;

- (i) the well established V_0 and r_s tangent used for rating purposes and
- (ii) a set of constants A, B, C, D, forming the coefficients of the representative equation for V_T in terms of I_T given below:

$$V_T = A + B \cdot \ln(I_T) + C \cdot I_T + D \cdot \sqrt{I_T}$$

The constants, derived by curve fitting software, are given below for both hot and cold characteristics. The resulting values for V_T agree with the true device characteristic over a current range, which is limited to that plotted.

| 25°C Coefficients | | 125°C Coefficients | |
|-------------------|---------------------------|--------------------|---------------------------|
| A | 0.5867719 | A | 0.022478405 |
| B | 0.1034432 | B | 0.2553937 |
| C | 6.597532×10^{-4} | C | 9.312906×10^{-4} |
| D | -0.0163 | D | -0.0424168 |

7.3 D.C. Thermal Impedance Calculation

$$r_t = \sum_{p=1}^{p=n} r_p \cdot \left(1 - e^{-\frac{t}{\tau_p}} \right)$$

Where $p = 1$ to n , n is the number of terms in the series and:

- t :Duration of heating pulse in seconds.
- r_t :Thermal resistance at time t .
- r_p :Amplitude of p_{th} term.
- τ_p :Time Constant of r_{th} term.

| D.C. Double Side Cooled | | | | |
|-------------------------|----------|----------|-------------------------|-------------------------|
| Term | 1 | 2 | 3 | 4 |
| r_p | 0.049575 | 0.032798 | 7.7357×10^{-3} | 3.5167×10^{-3} |
| τ_p | 0.34263 | 0.10058 | 0.0432379 | 3.388×10^{-3} |

| D.C. Single Side Cooled | | | | | |
|-------------------------|--------|---------|---------|----------|---------------------------|
| Term | 1 | 2 | 3 | 4 | 5 |
| r_p | 0.135 | 0.01177 | 0.04364 | 0.015709 | 2.292×10^{-3} |
| τ_p | 3.0077 | 1.16261 | 0.14258 | 0.04504 | 2.152267×10^{-3} |

8.0 Reverse recovery ratings

- (i) Q_{ra} is based on 50% I_{rm} chord as shown in Fig. 1.
- (ii) Q_{rr} is based on a 150 μ s integration time.

i.e.
$$Q_{rr} = \int_0^{150\mu s} i_{rr} \cdot dt$$

(iii)
$$K \text{ Factor} = \frac{t1}{t2}$$

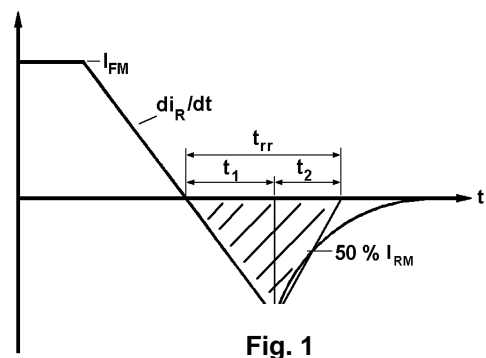

Curves

Figure 1 - On-state characteristics of Limit device

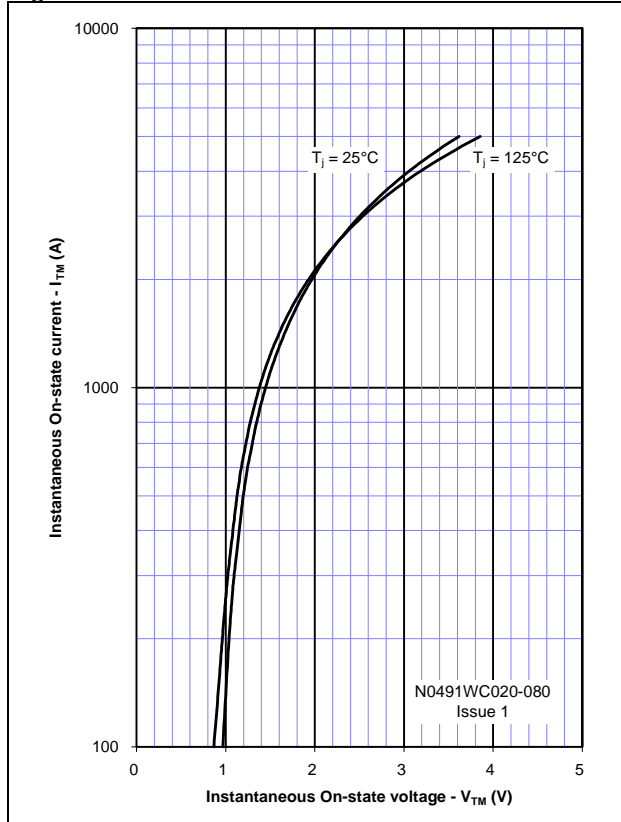

Figure 2 - Transient Thermal Impedance

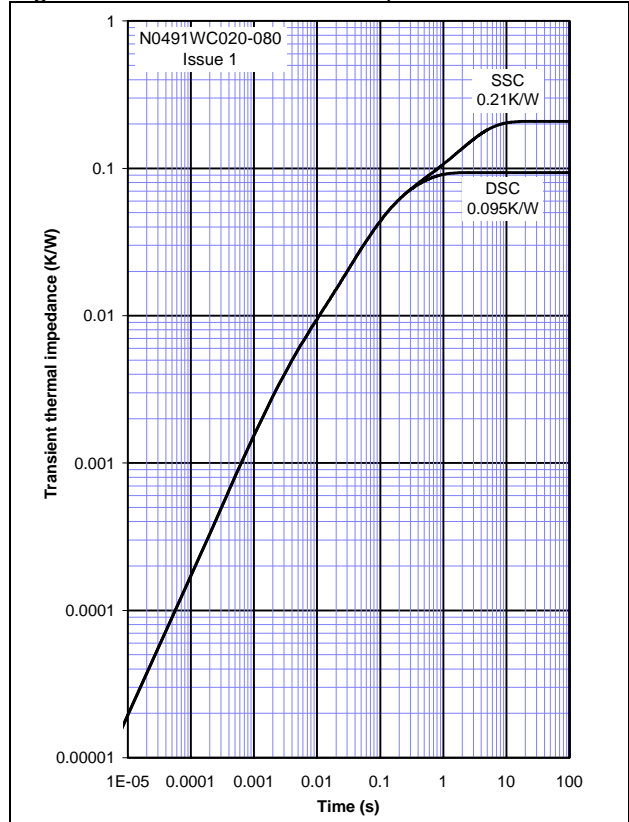

Figure 3 - Gate Characteristics - Trigger Limits

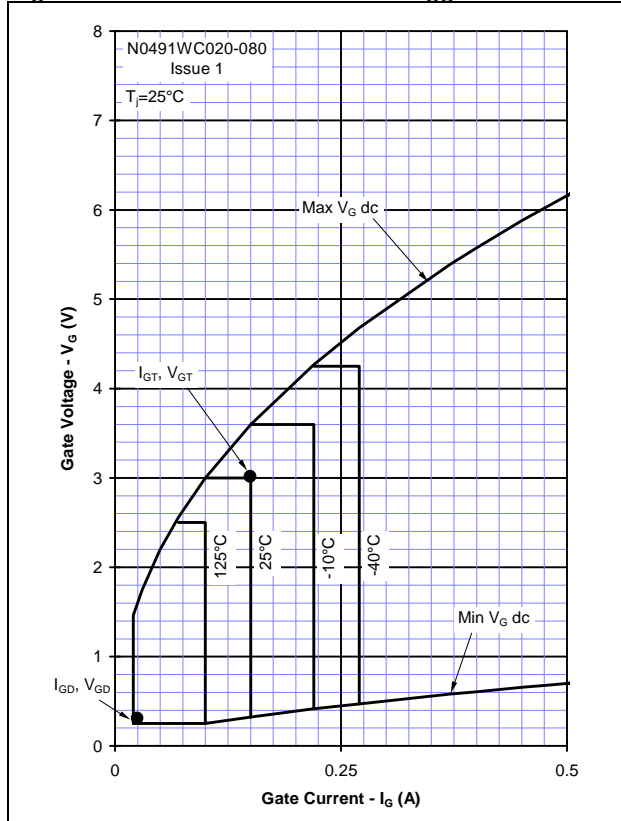

Figure 4 - Gate Characteristics - Power Curves

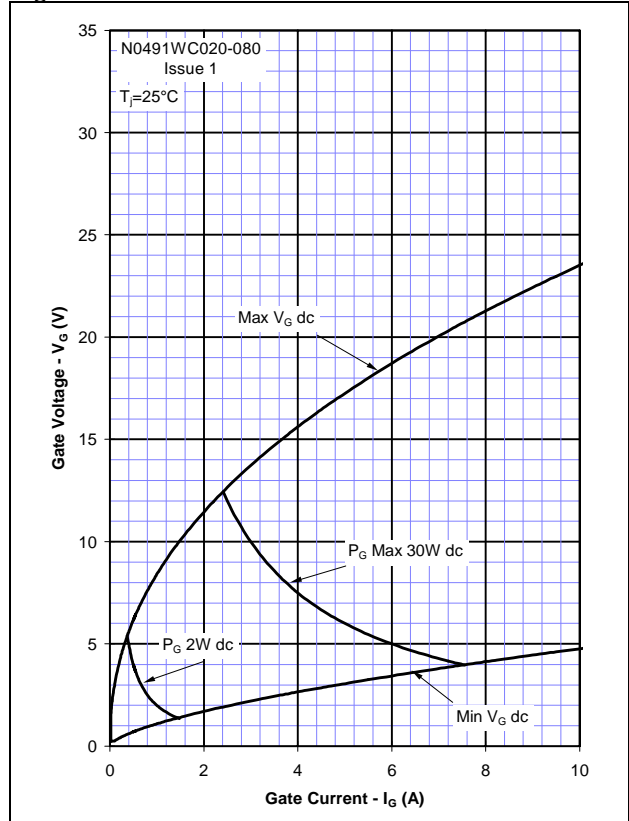

Figure 5 – Recovered Charge, Q_{rr}

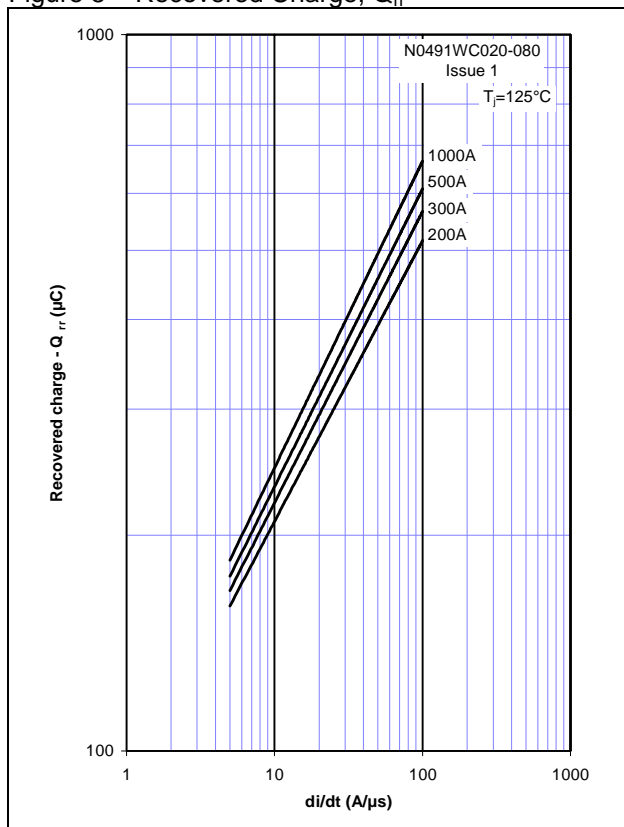

Figure 6 – Recovered charge, Q_{ra} (50% chord)

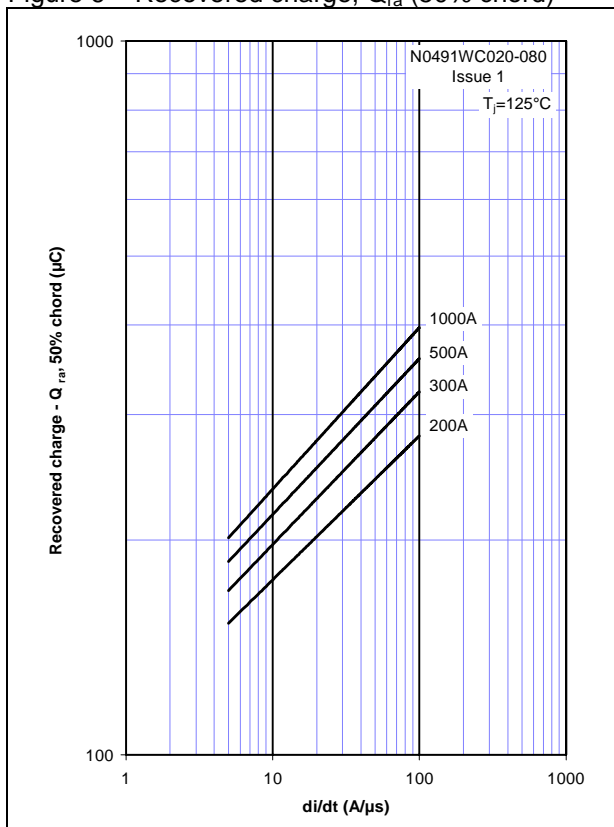

Figure 7 – Reverse recovery current, I_{rm}

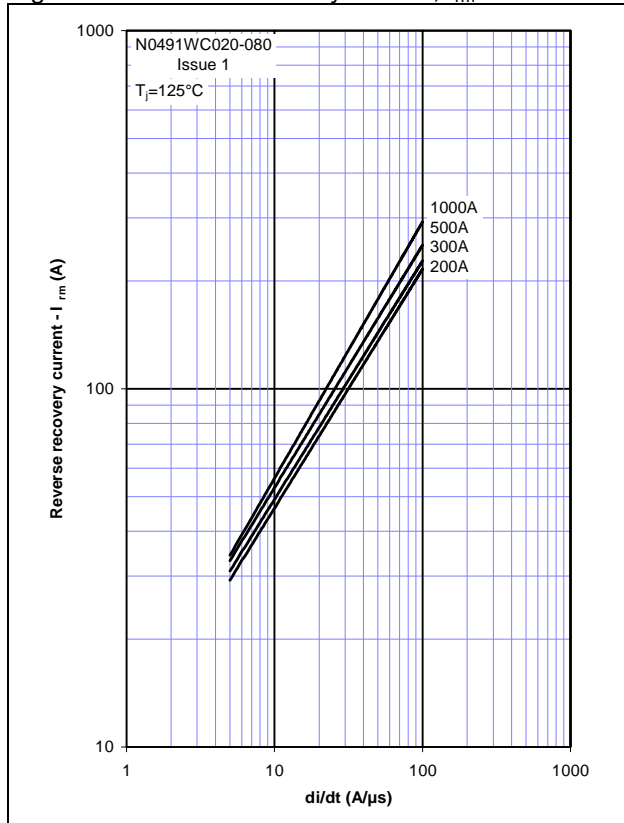

Figure 8 – Reverse recovery time, t_{rr} (50% chord)

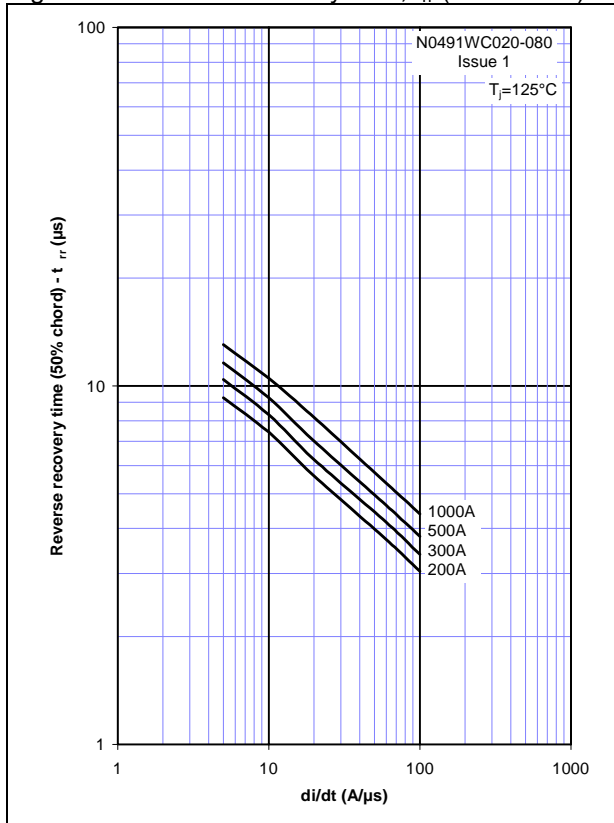

Figure 9 – On-state current vs. Power dissipation – Double Side Cooled (Sine wave)

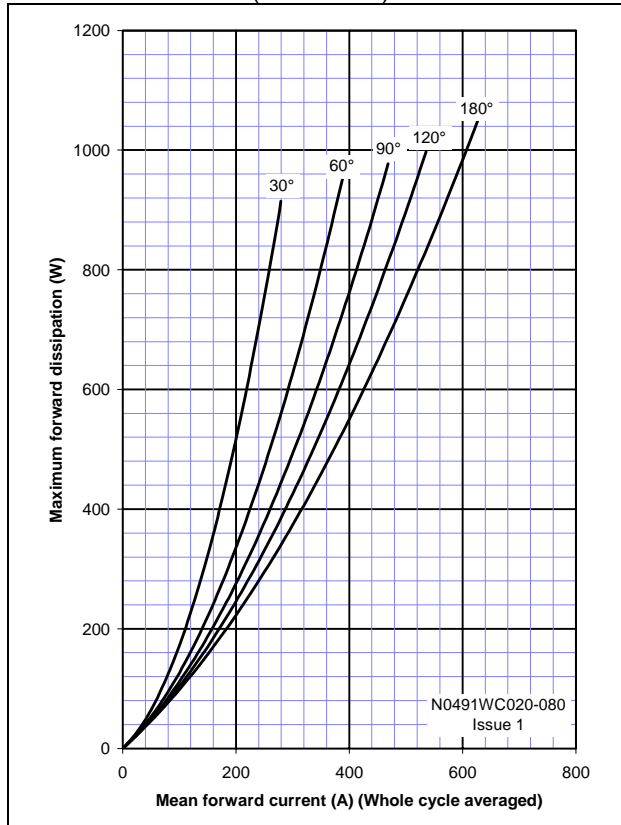

Figure 10 – On-state current vs. Heatsink temperature - Double Side Cooled (Sine wave)

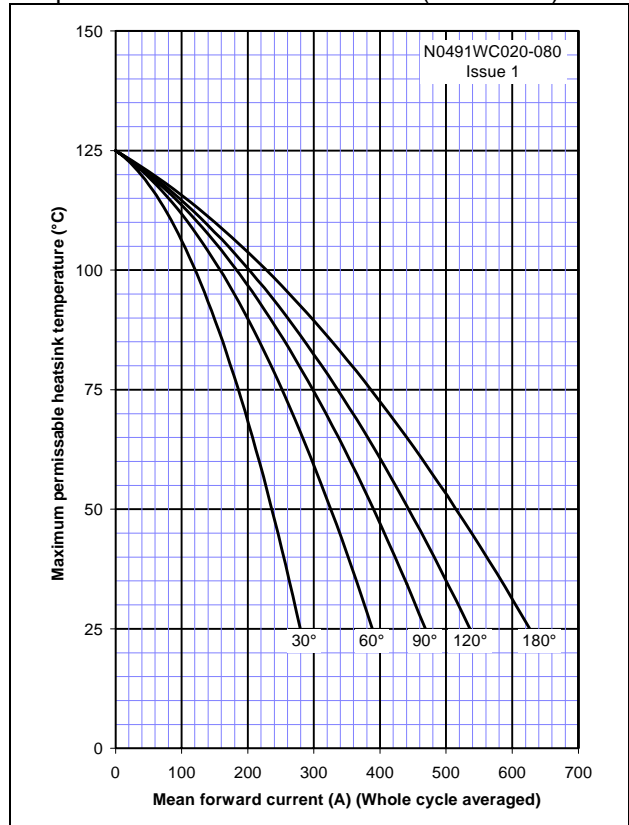

Figure 11 – On-state current vs. Power dissipation – Double Side Cooled (Square wave)

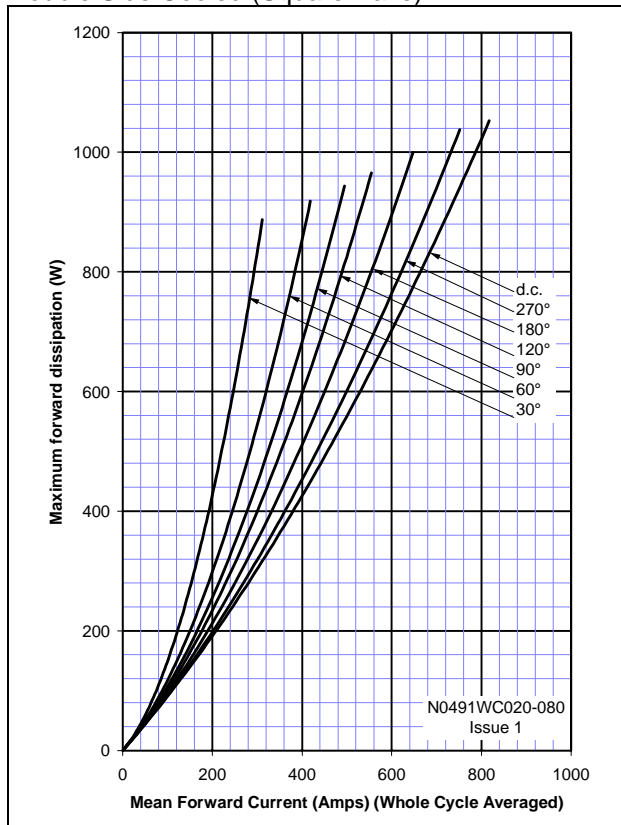

Figure 12 – On-state current vs. Heatsink temperature - Double Side Cooled (Square wave)

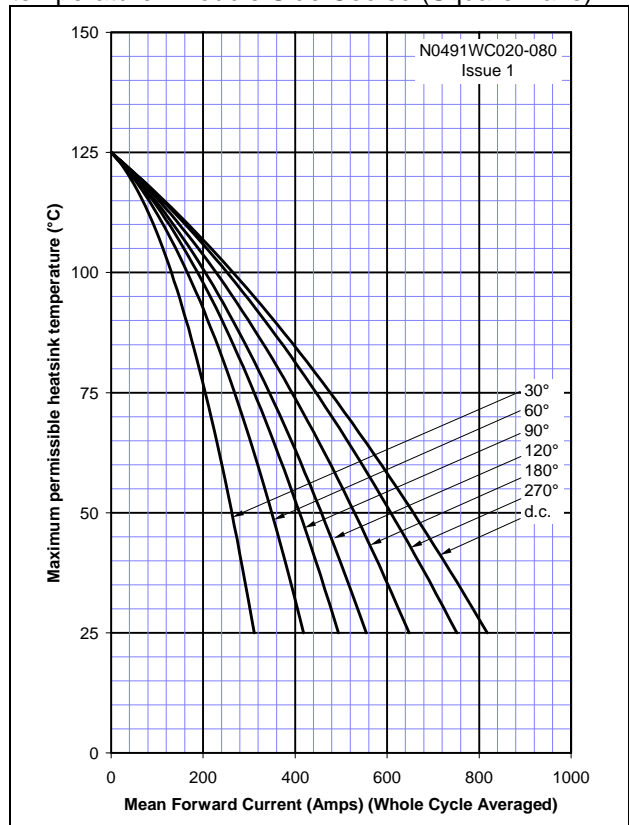

Figure 13 – On-state current vs. Power dissipation – Single Side Cooled (Sine wave)

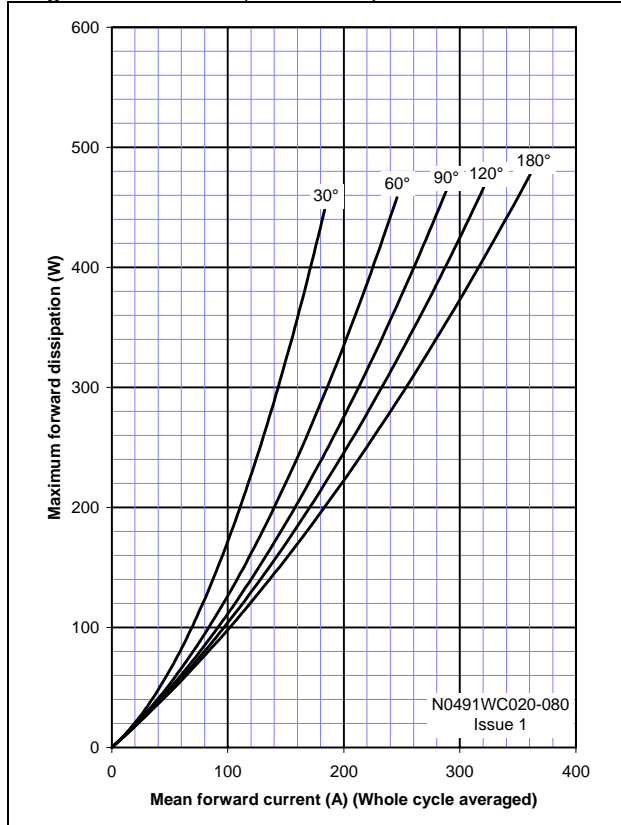

Figure 14 – On-state current vs. Heatsink temperature - Single Side Cooled (Sine wave)

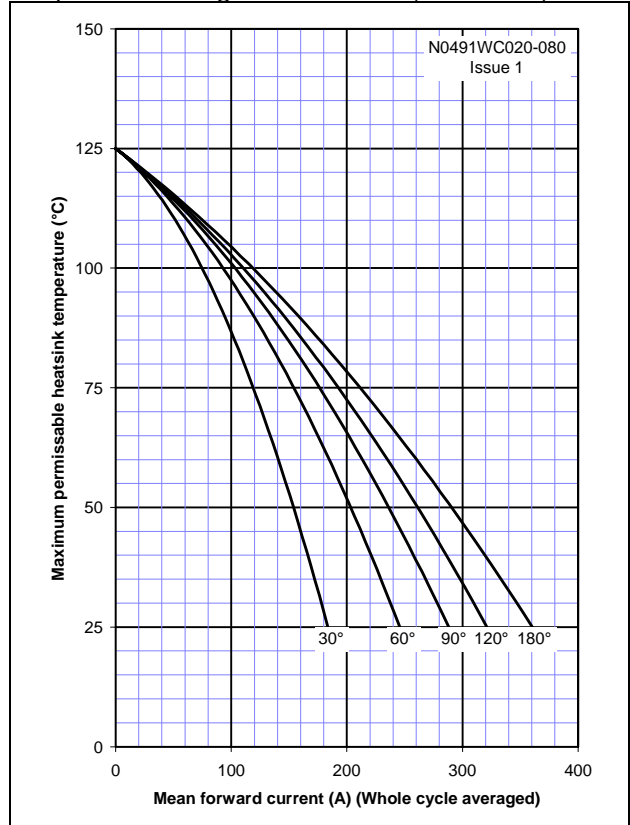

Figure 15 – On-state current vs. Power dissipation – Single Side Cooled (Square wave)

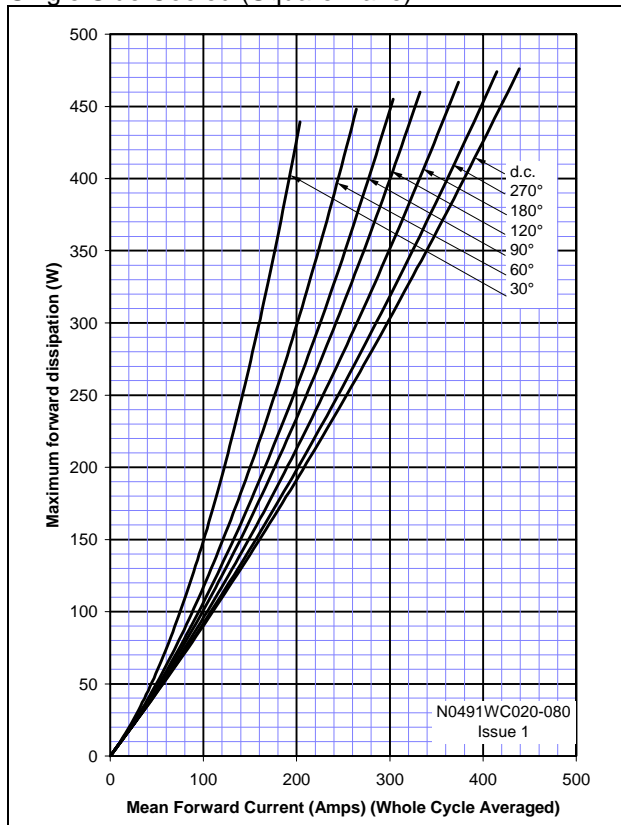

Figure 16 – On-state current vs. Heatsink temperature - Single Side Cooled (Square wave)

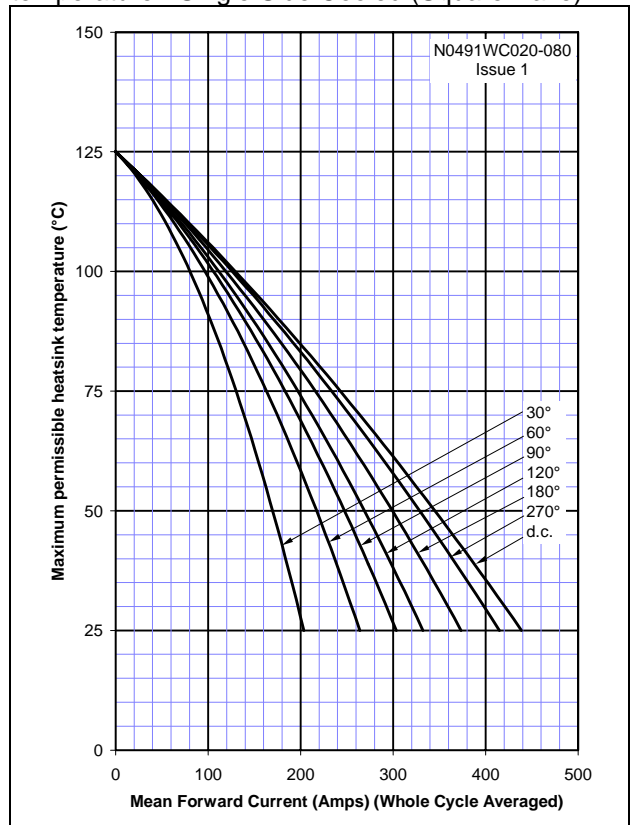
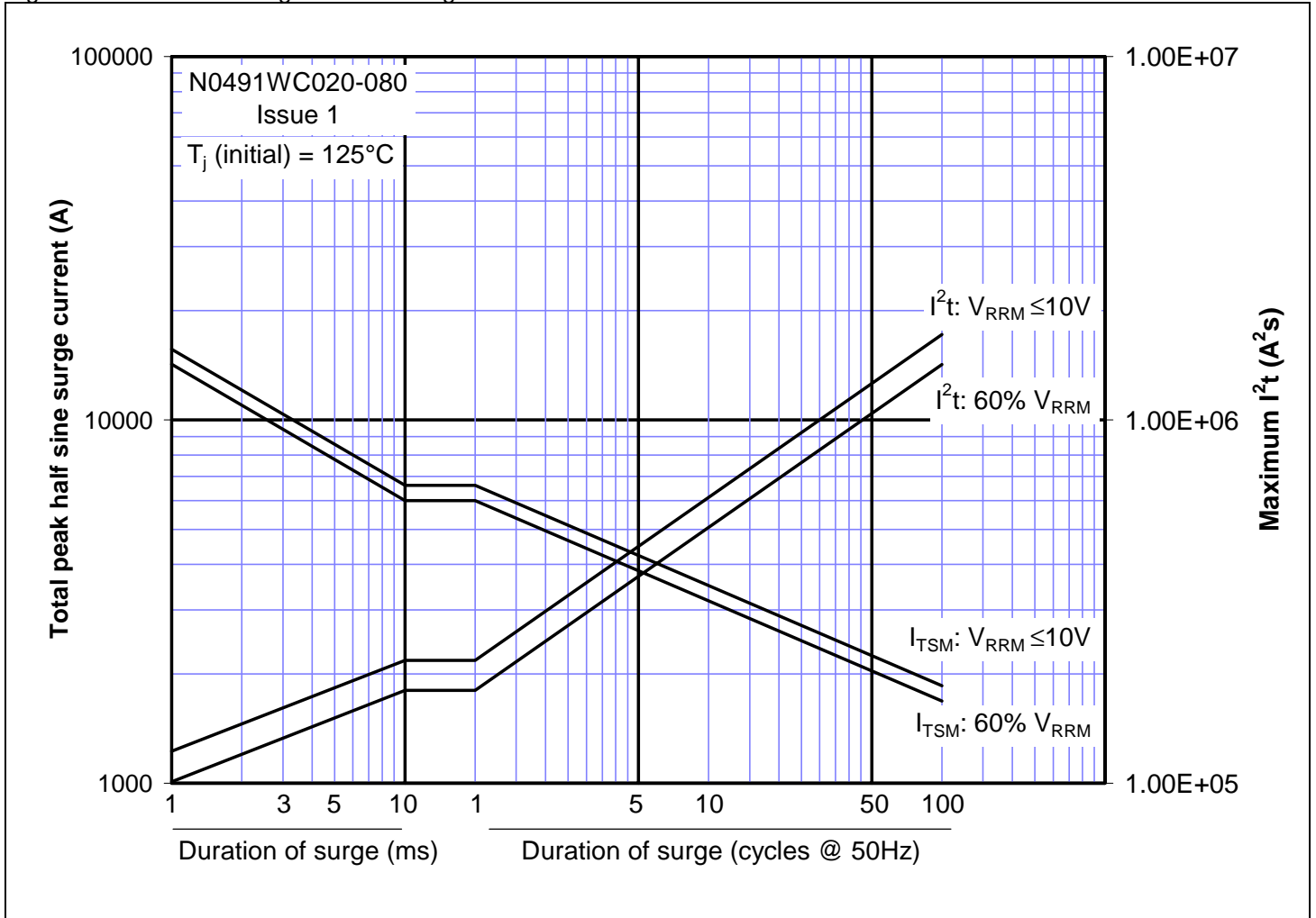
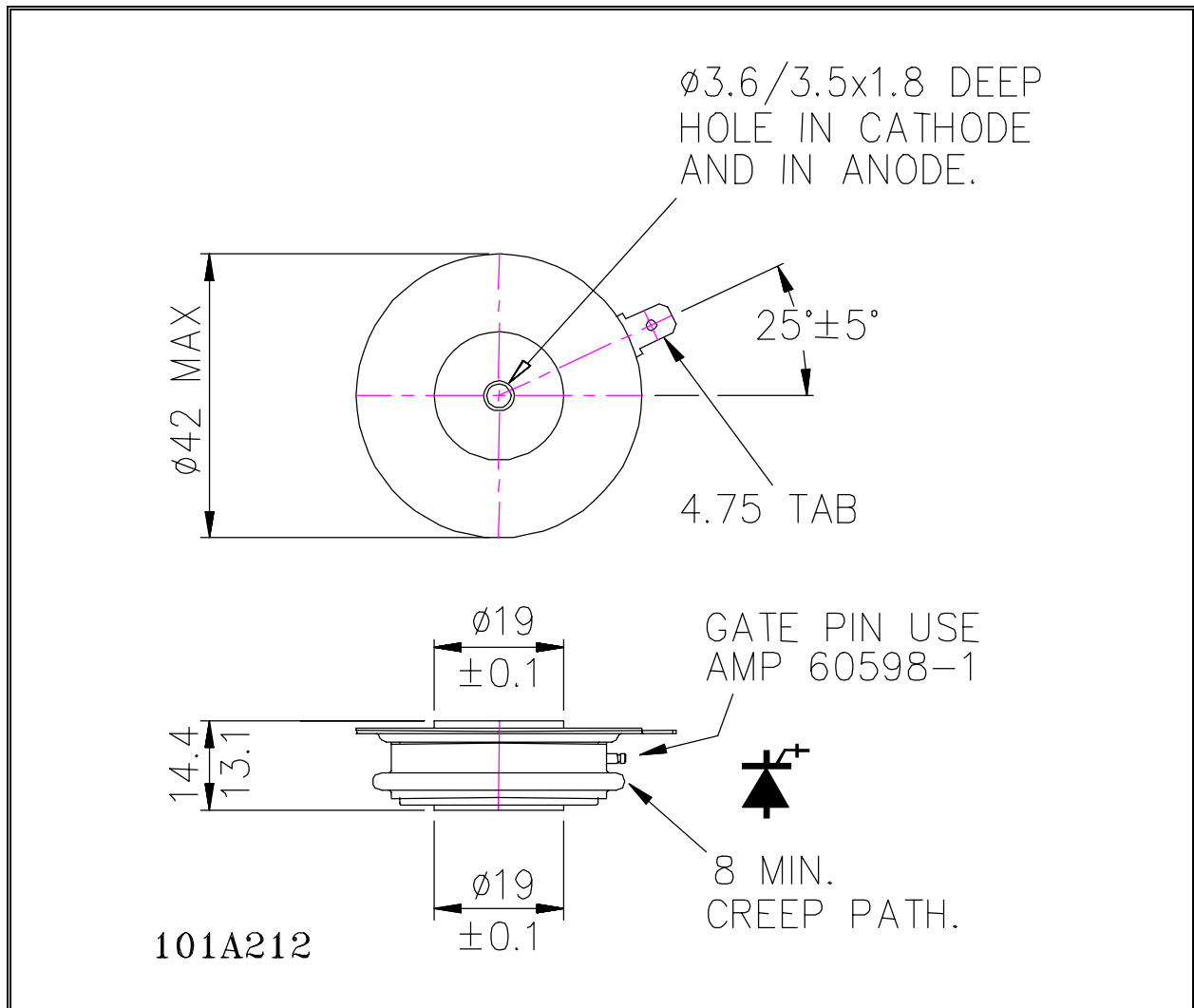

Figure 17 – Maximum surge and I^2t Ratings



Outline Drawing & Ordering Information



ORDERING INFORMATION (Please quote 10 digit code as below)

| | | | |
|-----------------|--------------------|--------------------|--------------------------|
| N0491 | WC | ◆◆ | 0 |
| Fixed Type Code | Fixed Outline Code | Voltage Code 02-08 | Fixed turn-off time code |

Typical order code: N0491WC060 – 600V V_{DRM}/V_{RRM} , 14.4mm clamp height capsule.

WESTCODE

UK: Westcode Semiconductors Ltd.
P.O. Box 57, Chippenham, Wiltshire, England. SN15 1JL.
Tel: +44 (0) 1249 444524 Fax: +44 (0) 1249 659448
E-Mail: WSL.sales@westcode.com

USA: Westcode Semiconductors Inc.
3270 Cherry Avenue, Long Beach, California 90807
Tel: +1 (562) 595 6971 Fax: +1 (562) 595 8182
E-Mail: WSI.sales@westcode.com

Internet: <http://www.westcode.com>

The information contained herein is confidential and is protected by Copyright. The information may not be used or disclosed except with the written permission of and in the manner permitted by the proprietors Westcode Semiconductors Ltd. © Westcode Semiconductors Ltd.

In the interest of product improvement, Westcode reserves the right to change specifications at any time without prior notice.

Devices with a suffix code (2-letter or letter/digit/letter combination) added to their generic code are not necessarily subject to the conditions and limits contained in this report.